



微信 WeChat



Web

浙江欧锐杰照明科技有限公司
ZHEJIANG OURUIJIELIGHTING TECHNOLOGY CO.,LTD.

ADD: 浙江省湖州市广源路328号3栋
Building 3 No. 328 Guangyuan Road, Huzhou, Zhejiang, China
TEL: +86-572-2671188
FAX: +86-572-2671800
E-mail: orj@orjlight.com





天玺
超级配光

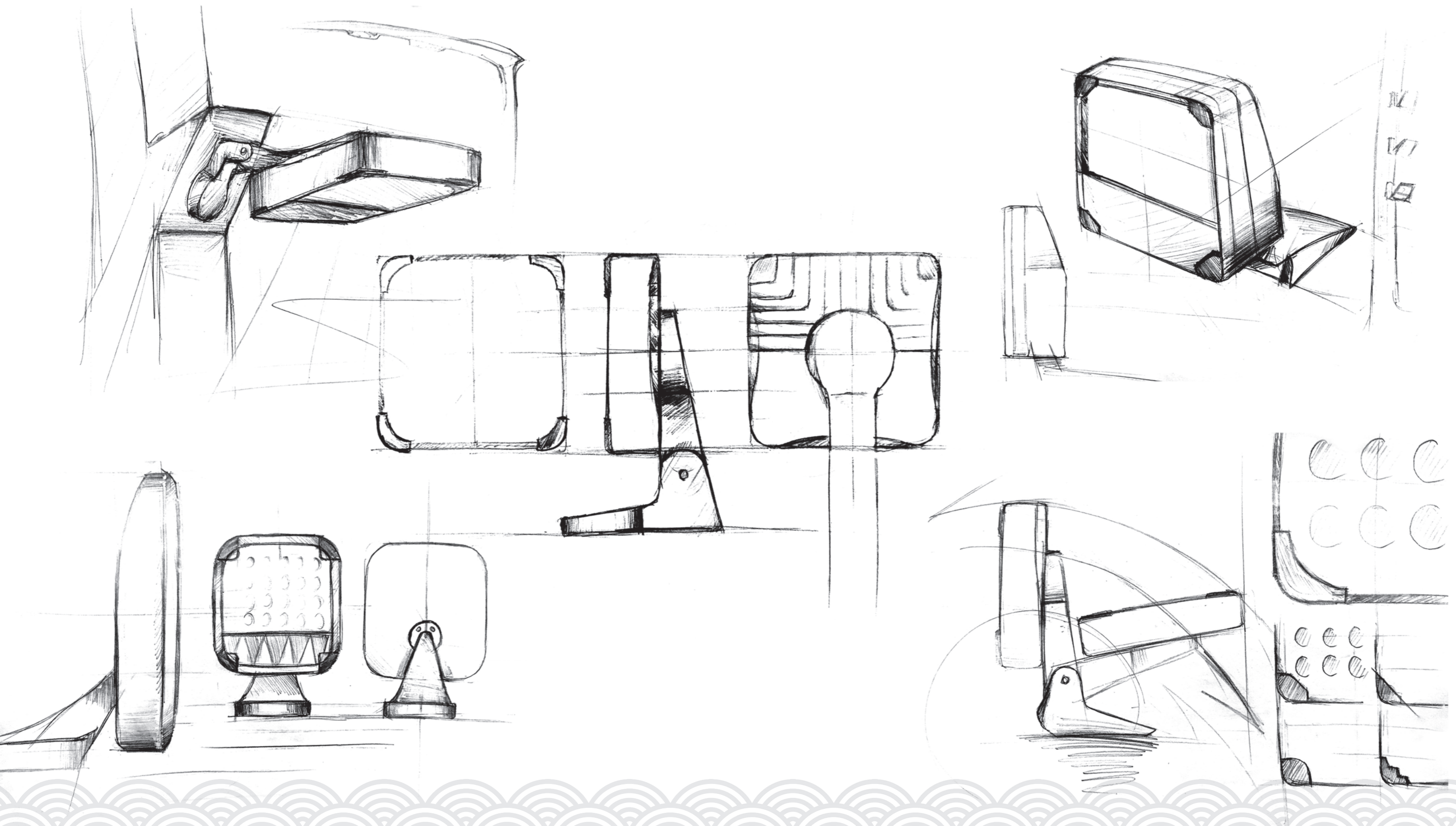

天玺™ 超级配光 投光灯系列

- 天玺™ 系列投光灯，灯体采用高强度压铸铝材料，表面静电喷塑处理；采用最新的导流散热设计，均匀性更好；适用于建筑、园林、景观照明应用；
- 内置隐藏式线路结构，灯具无外露线，安全美观可靠，防护等级IP66；
- 垂直方向0~360°可旋转角度，水平方向0~120°可旋转角度，安全自锁结构设计，满足户外的多种场合应用；
- 采用多角度配光需求，满足各类建筑的照明如：柱子（宽，窄）、墙面、屋檐等。

TIANXI™ FLOOD LIGHT SERIES

- Tianxi™ series flood lamp adopts high-strength die-casting aluminum material and surface electrostatic spraying treatment; adopts isolated double cavity design and the latest diversion heat dissipation design, with better uniformity;
- Hidden cables structure, lamps without exposed wire, safe, beautiful and reliable, protection grade Ip66;
- It can rotate from 0° to 360° in the vertical direction, and from 0° to 120° in the horizontal direction. The design of safety self-locking structure can meet various outdoor applications;
- Multi angle light distribution is adopted to meet the lighting requirements of various buildings, such as columns (wide, narrow), walls, eaves, etc.

超级防眩 Super anti-glare

天玺™ 内置多重防眩功能

Tianxi™ Multi anti-glare function



三轴转向 Three directions of rotation

天玺™ 独具三轴支架设计，转向无死角

Tianxi™ Unique three directions of rotation bracket design, rotating free

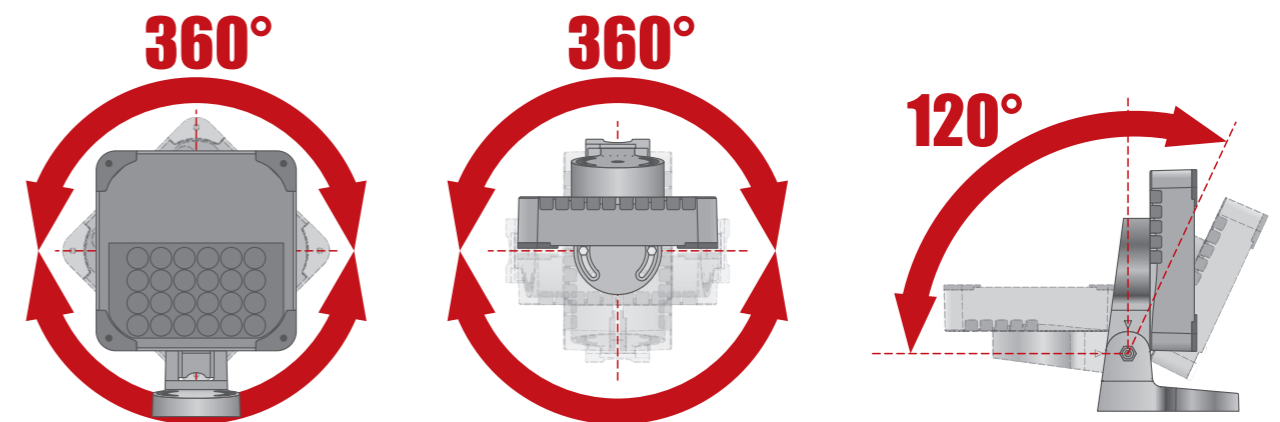

灵活安装 Flexible installation

支架双向安装、调节，应用更灵活

The bracket has its own distance of back light, which makes the installation more flexible

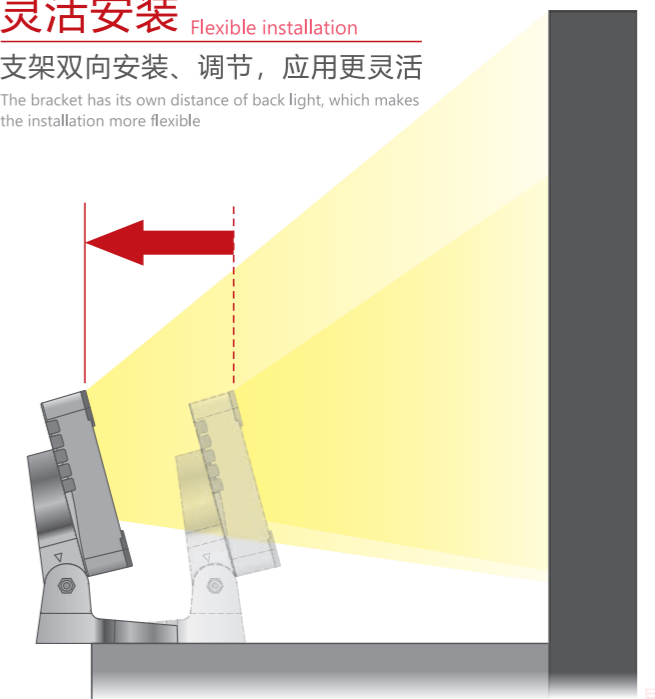

极致超薄 Ultra thin

天玺™将空间布局安排到极致，保留所有功能后且灯体超薄。

TianXi™ Arrange the space layout to the extreme, keep all the functions and the lamp body is ultra-thin

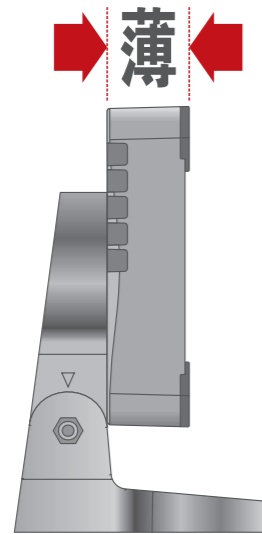

隐藏接线 Hidden wiring

天玺™可将出线及电缆固定头隐藏于灯体内部

TianXi™ The cable and connector can be hidden inside the lamp body



超级配光 Super light distribution

天玺™投光灯具备全系配光角度

TianXi™ Cast light With full range of light distribution angle



天玺 L02C-G

IP66 IK08 CE

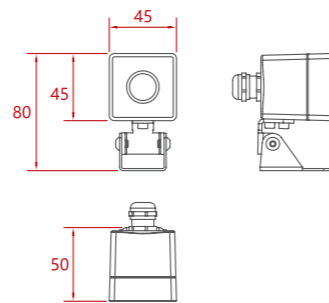

L02C-001G

DC 24V 3000/4000/5700K	LED Quantity	Rated Power	Luminous Flux	Optical Angle	Lamp Size	Net Weight	Gross Weight/Packing Size
● ● ●	1 pcs	3 W	267 lm	7°/10°/15°/25°/40°/60°/90°/120° 15×55°/15×30°/15×45° 4×50°/13×40°/30×60°	80×50×45mm	0.3 kg	0.4 kg/130×110×100(1pcs/box) 13.9 kg/520×390×260(45pcs/box)

L02C-001G 3W 10°

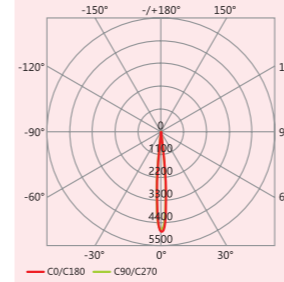

h(m)	Eavg(lx)	Emax(lx)	D(m)
1	3336	5162	0.18
2	834	1290	0.36
3	370	573	0.54
4	208	322	0.72
5	133	206	0.9

L02C-001G 3W 15°

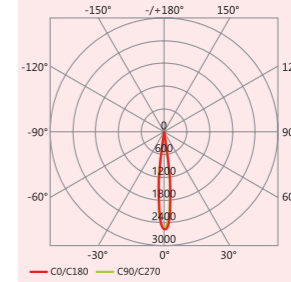

h(m)	Eavg(lx)	Emax(lx)	D(m)
1	1808	2695	0.24
2	451	673	0.39
3	200	299	0.73
4	113	168	0.97
5	72	107	1.121

L02C-001G 3W 25°

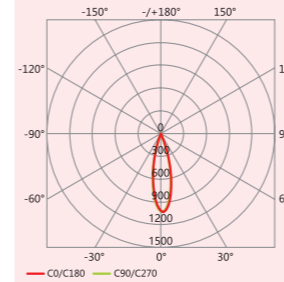

h(m)	Eavg(lx)	Emax(lx)	D(m)
1	706	1050	0.47
2	176	262	0.94
3	78	116	1.41
4	44	65	1.89
5	28	42	2.36

L02C-001G 3W 40°

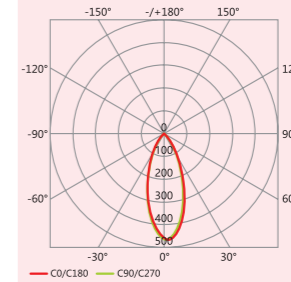

h(m)	Eavg(lx)	Emax(lx)	D(m)
1	306	469	0.68
2	76	117	1.37
3	34	52	2.05
4	19	29	2.74
5	12	18	3.42

L02C-001G 3W 60°

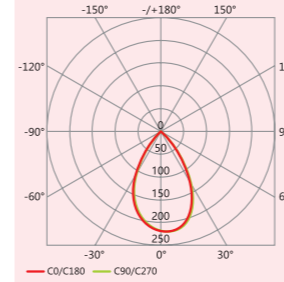

h(m)	Eavg(lx)	Emax(lx)	D(m)
1	133	220	1.18
2	33	55	2.37
3	14	24	3.55
4	8	13	4.74
5	5	9	5.93

L02C-001G 3W 120°

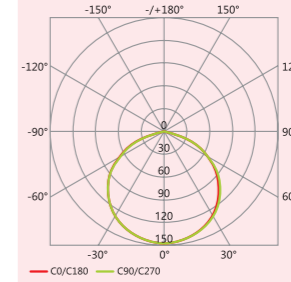

h(m)	Eavg(lx)	Emax(lx)	D(m)
1	21	73	3.07
2	5	18	6.14
3	2	8	9.21
4	1	4	12.29
5	1	3	15.36

L02C-001G 3W 15×55°

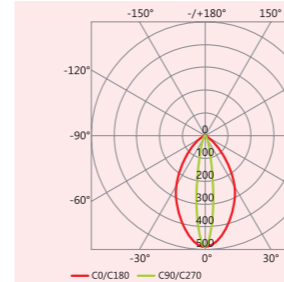

L02C-001G 3W 15×30°

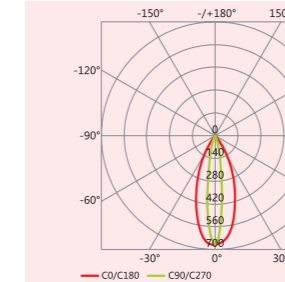

L02C-001G 3W 12×25°

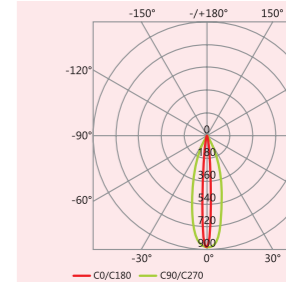

L02C-001G 3W 30×60°

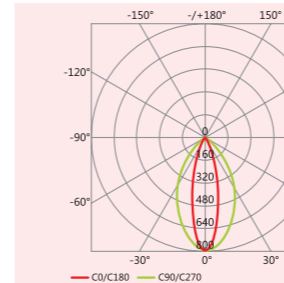

L02C-001G 3W 4×50°

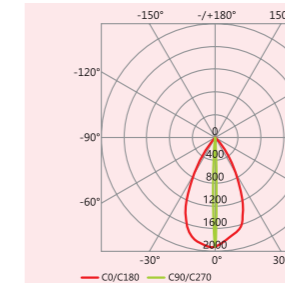

L02C-001G 3W 15×40°

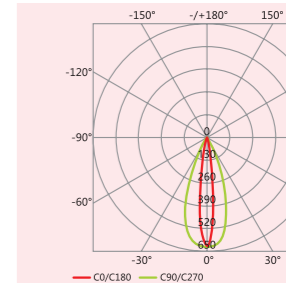

天玺 L02C-F

超级配光

IP66 IK08 CE

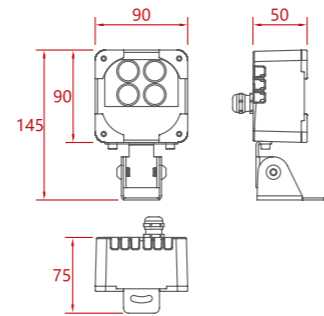

L02C-001F

DC 24V 3000/4000/5700K	LED Quantity	Rated Power	Luminous Flux	Optical Angle	Lamp Size	Net Weight	Gross Weight/Packing Size
● ● ●	1 pcs	3 W	203 lm	3°/5°	145×90×75mm	0.8 kg	0.9 kg/240×150×120(1pcs/box) 1.1 kg/440×350×250(9pcs/box)

L02C-004F

DC 24V 3000/4000/5700K	LED Quantity	Rated Power	Luminous Flux	Optical Angle	Lamp Size	Net Weight	Gross Weight/Packing Size
● ● ●	4 pcs	9 W	813 lm	7°/10°/15°/25°/40°/60°/90°/120° 15°×55°/15°×30°/15°×45° 4°×50°/13°×40°/30°×60°	145×90×75mm	0.8 kg	0.9 kg/240×150×120(1pcs/box) 1.1 kg/440×350×250(9pcs/box)

L02C-001F 3W 3°

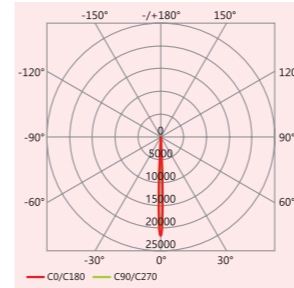

h(m)	Eavg(lx)	Emax(lx)	D(m)
1	1618	21933	0.05
2	3545	5483	0.11
3	1576	2437	0.16
4	886	1371	0.22
5	567	877	0.27

L02C-001F 3W 5°

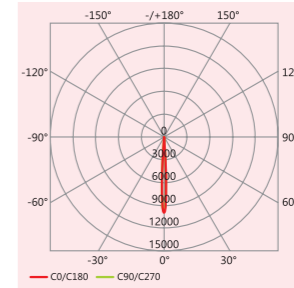

h(m)	Eavg(lx)	Emax(lx)	D(m)
1	6814	10149	0.09
2	1703	2537	0.18
3	757	1128	0.27
4	425	634	0.36
5	272	405	0.45

L06B-004F 9W 10°

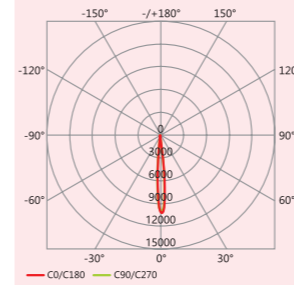

h(m)	Eavg(lx)	Emax(lx)	D(m)
1	7005	10840	0.18
2	1751	2710	0.36
3	778	1204	0.54
4	437	677	0.72
5	280	433	0.9

L02C-004F 9W 15°

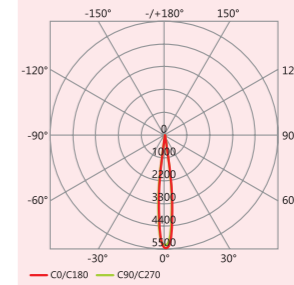

h(m)	Eavg(lx)	Emax(lx)	D(m)
1	3778	5632	0.24
2	944	1408	0.39
3	419	625	0.73
4	236	352	0.97
5	151	225	1.121

L02C-004F 9W 25°

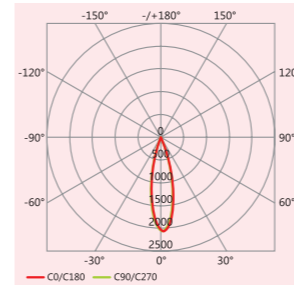

h(m)	Eavg(lx)	Emax(lx)	D(m)
1	1414	2099	0.47
2	353	524	0.94
3	157	233	1.41
4	88	131	1.89
5	56	83	2.36

L02C-004F 9W 40°

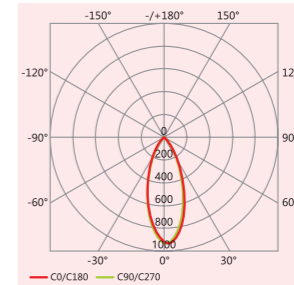

h(m)	Eavg(lx)	Emax(lx)	D(m)
1	627	962	0.68
2	156	240	1.37
3	69	107	2.05
4	39	60	2.74
5	25	38	3.42

L02C-004F 9W 60°

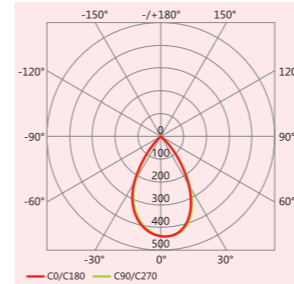

h(m)	Eavg(lx)	Emax(lx)	D(m)
1	272	452	1.18
2	68	113	2.37
3	30	50	3.55
4	17	28	4.74
5	10	18	5.93

L02C-004F 9W 120°

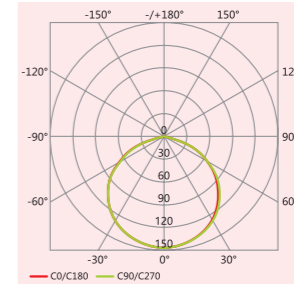

h(m)	Eavg(lx)	Emax(lx)	D(m)
1	43	147	3.07
2	10	36	6.14
3	4	16	9.21
4	2	9	12.29
5	1	5	15.36

L02C-004F 9W 15×55°

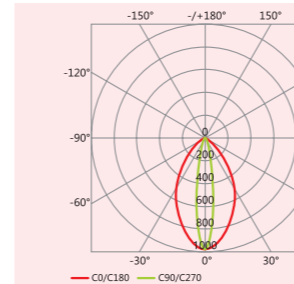

L02C-004F 9W 15×30°

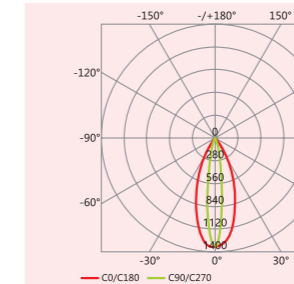

L02C-004F 9W 12×25°

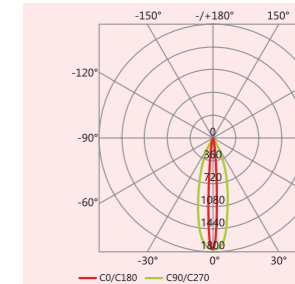

L02C-004F 9W 30×60°

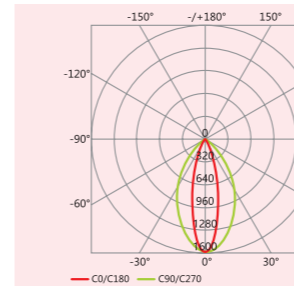

L02C-004F 9W 4×50°

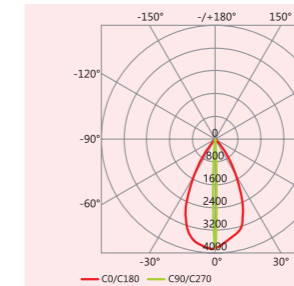

L02C-004F 9W 15×40°

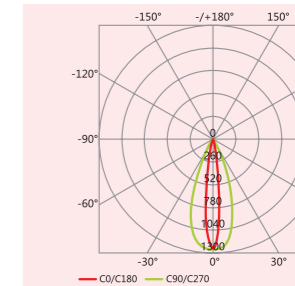

天空
超级配光
L02C-D

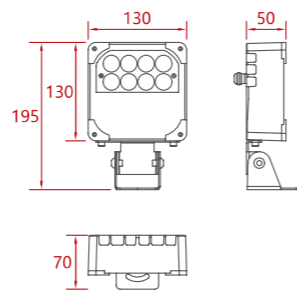
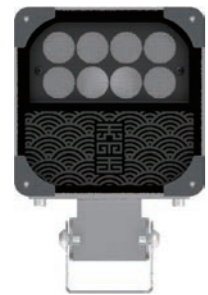

L02C-002D

DC 24V



LED Quantity	Rated Power	Luminous Flux	Optical Angle	Lamp Size	Net Weight	Gross Weight/Packing Size
2pcs/RGBW	20 W	718 lm	15°/25°/40°/60°	235×160×130mm	1.2 kg	1.4 kg/230×210×130(1pcs/box) 7.6 kg/440×350×250(6pcs/box)

L02C-006D

AC 220V
3000/4000/5700K



LED Quantity	Rated Power	Luminous Flux	Optical Angle	Lamp Size	Net Weight	Gross Weight/Packing Size
6 pcs	14 W	855 lm	3°/5°	235×160×130mm	1.3 kg	1.5 kg/230×210×130(1pcs/box) 5.2 kg/440×350×250(6pcs/box)

L02C-008D

AC 220V
3000/4000/5700K



LED Quantity	Rated Power	Luminous Flux	Optical Angle	Lamp Size	Net Weight	Gross Weight/Packing Size
8 pcs	16 W	1481 lm	7°/10°/15°/25°/40°/60°/90°/120° 15×55°/15×30°/15×45° 4×50°/13×40°/30×60°	235×160×130mm	1.3 kg	1.5 kg/230×210×130(1pcs/box) 5.2 kg/440×350×250(6pcs/box)

L02C-006D 14W 3°

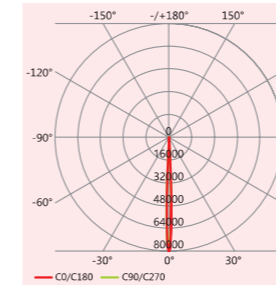

h(m)	Eavg(lx)	Emax(lx)	D(m)
1	51944	80349	0.05
2	12986	20087	0.11
3	3247	5022	0.16
4	1443	2232	0.22
5	519	803	0.27

L02C-006D 14W 5°

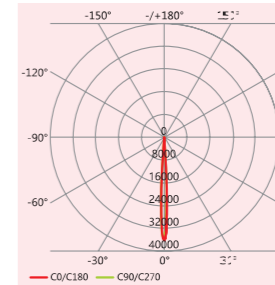

h(m)	Eavg(lx)	Emax(lx)	D(m)
1	24988	37219	0.09
2	6247	9305	0.18
3	2776	4125	0.27
4	1582	2326	0.36
5	999	1459	0.45

L02C-008D 18W 10°

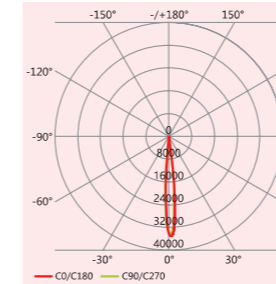

h(m)	Eavg(lx)	Emax(lx)	D(m)
1	23536	36419	0.18
2	5884	9105	0.36
3	2615	4047	0.54
4	1471	2276	0.72
5	941	1457	0.9

L02C-008D 18W 15°

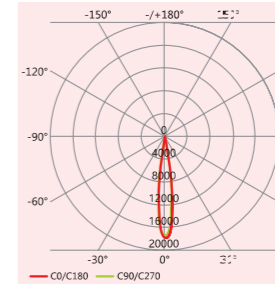

h(m)	Eavg(lx)	Emax(lx)	D(m)
1	12591	18770	0.24
2	3148	4692	0.39
3	1559	2056	0.73
4	787	1175	0.97
5	503	750	1.121

L02C-008D 18W 25°

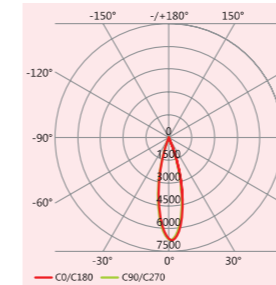

h(m)	Eavg(lx)	Emax(lx)	D(m)
1	4712	6998	0.47
2	1178	1750	0.94
3	523	777	1.41
4	294	437	1.89
5	188	279	2.36

L02C-008D 18W 40°

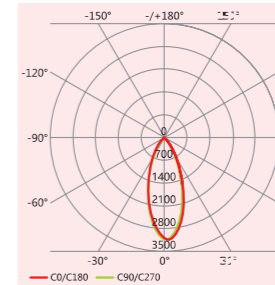

h(m)	Eavg(lx)	Emax(lx)	D(m)
1	2051	3209	0.68
2	522	802	1.37
3	232	356	2.05
4	130	200	2.74
5	83	125	3.42

L02C-008D 18W 60°

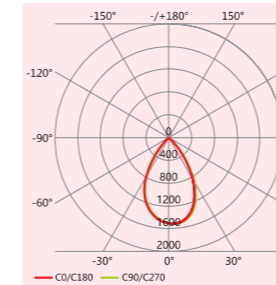

h(m)	Eavg(lx)	Emax(lx)	D(m)
1	908	1508	1.18
2	227	376	2.37
3	101	167	3.55
4	56	94	4.74
5	36	60	5.93

L02C-008D 18W 120°

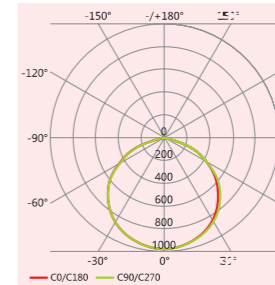

h(m)	Eavg(lx)	Emax(lx)	D(m)
1	143	490	3.07
2	55	122	6.14
3	15	54	9.21
4	8	30	12.29
5	5	19	15.36

天玺 L02C-B 超级配光

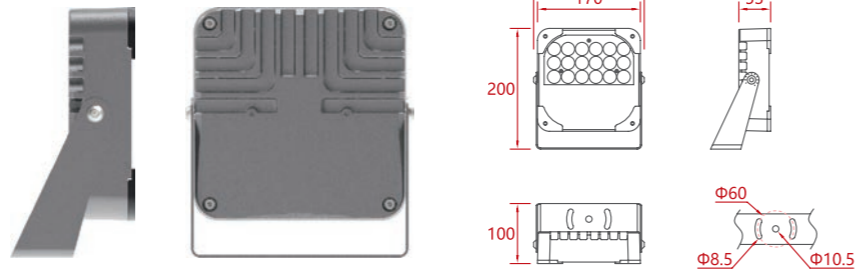
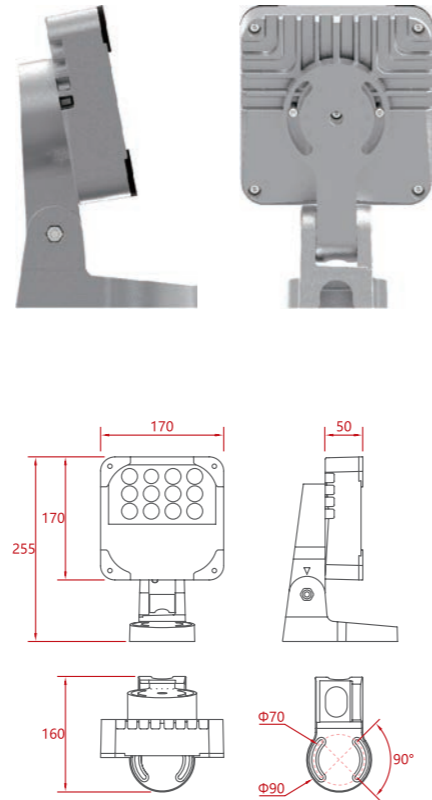

L02C-004B

AC 220V



LED Quantity	Rated Power	Luminous Flux	Optical Angle	Lamp Size	Net Weight	Gross Weight/Packing Size
4pcs/RGBW	40 W	1424 lm	15°/25°/40°/60°	255×170×160mm	2.4 kg	2.6 kg/320×270×190(1pcs/box) 9.9 kg/540×370×320(4pcs/box)

L02C-008B

AC 220V
3000/4000/5700K



LED Quantity	Rated Power	Luminous Flux	Optical Angle	Lamp Size	Net Weight	Gross Weight/Packing Size
8 pcs	25 W	1625 lm	3°/5°	255×170×160mm	2.4 kg	2.6 kg/320×270×190(1pcs/box) 9.9 kg/540×370×320(4pcs/box)

L02C-018B

AC220V
3000/4000K/RGB



LED Quantity	Rated Power	Luminous Flux	Optical Angle	Lamp Size	Net Weight	Gross Weight/Packing Size
18 pcs	40 W	3817 lm	7°/10°/15°/25°/40°/60°/90°/120° 15×55°/15×30°/15×45° 4×50°/13×40°/30×60°	255×170×160mm	2.5 kg	2.7 kg/320×270×190(1pcs/box) 10.3 kg/540×370×320(4pcs/box)

L02C-008B 25W 3°

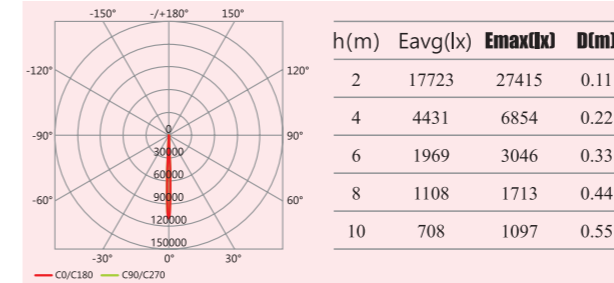

L02C-008B 25W 5°

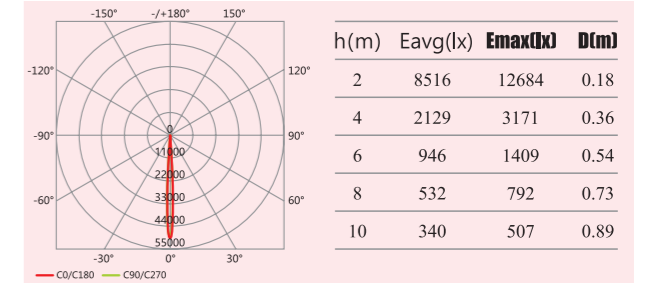

L02C-018B 40W 10°

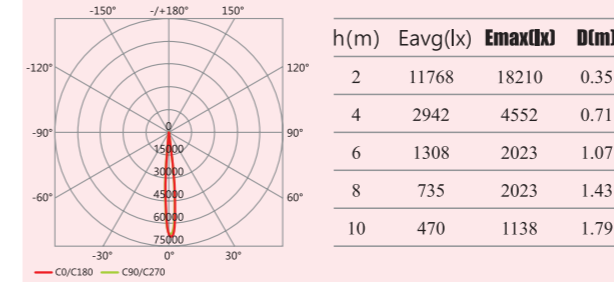

L02C-018B 40W 15°

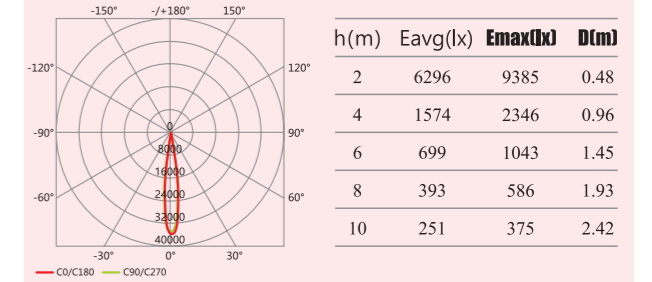

L02C-018B 40W 25°

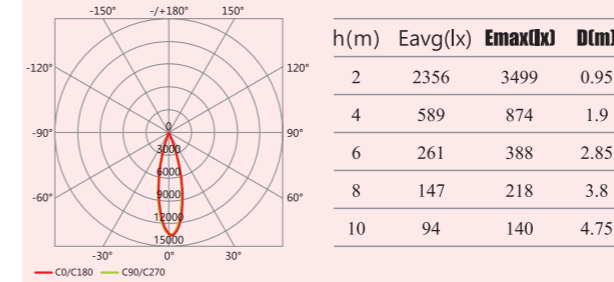

L02C-018B 40W 40°

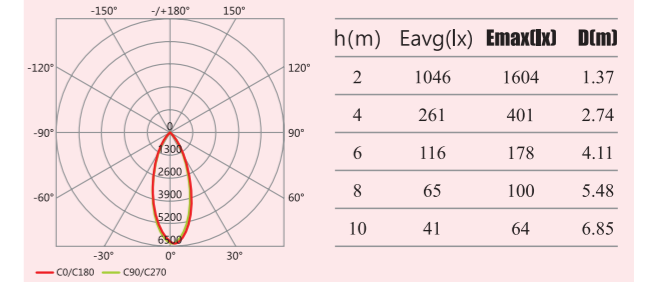

L02C-018B 40W 60°

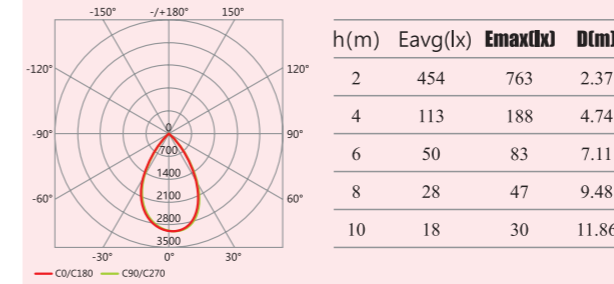

L02C-018B 40W 120°

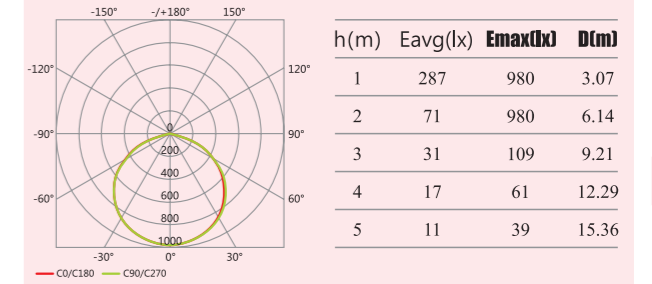

天玺 L02C-A 超级配光

IP66 IK08 CE

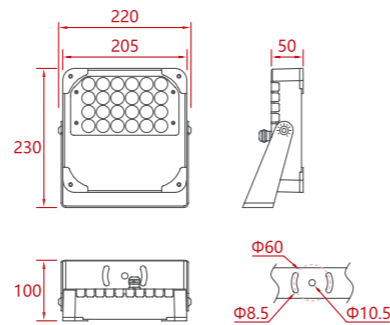
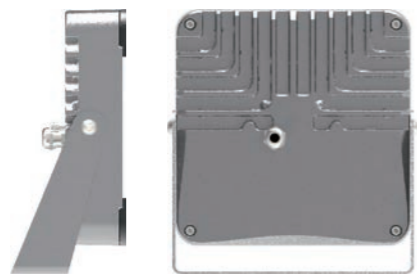
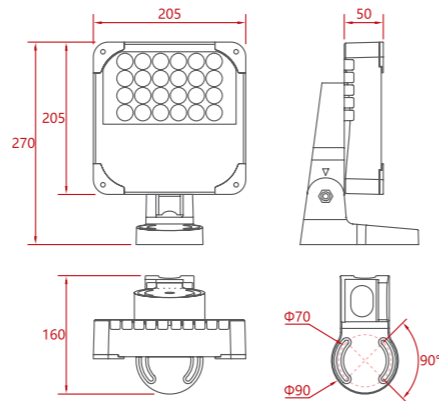
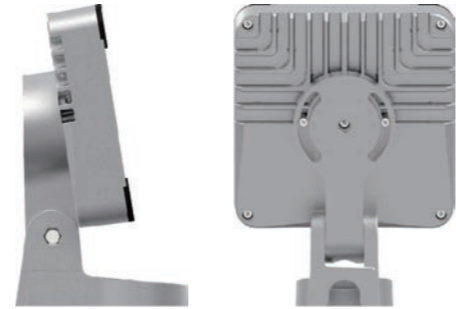

L02C-006A

AC 220V	LED Quantity	Rated Power	Luminous Flux	Optical Angle	Lamp Size	Net Weight	Gross Weight/Packing Size
	6pcs/RGBW	60 W	2142 lm	15°/25°/40°/60°	270×205×160mm	3.0 kg	3.2 kg/340×340×190(1pcs/box) 9.4 kg/540×370×320(3pcs/box)

L02C-012A

AC 220V	LED Quantity	Rated Power	Luminous Flux	Optical Angle	Lamp Size	Net Weight	Gross Weight/Packing Size
3000/4000/5700K 	12 pcs	40 W	2728 lm	3°/5°	270×205×160mm	3.0 kg	3.2 kg/340×340×190(1pcs/box) 9.4 kg/540×370×320(3pcs/box)

L02C-024A

AC 220V	LED Quantity	Rated Power	Luminous Flux	Optical Angle	Lamp Size	Net Weight	Gross Weight/Packing Size
3000/4000K/RGBW 	24 pcs	60 W	5192 lm	7°/10°/15°/25°/40°/60°/90°/120° 15×55°/15×30°/15×45° 4×50°/13×40°/30×60°	270×205×160mm	3.1 kg	3.3 kg/340×340×190(1pcs/box) 9.7 kg/540×370×320(3pcs/box)

L02C-012A 40W 3°

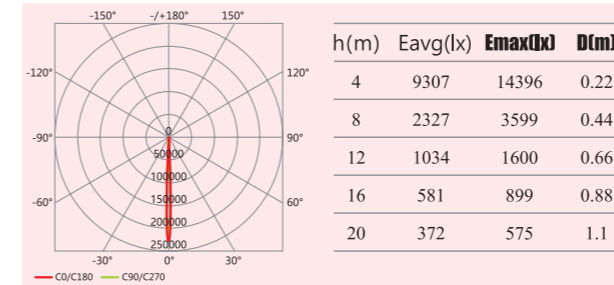

L02C-012A 40W 5°

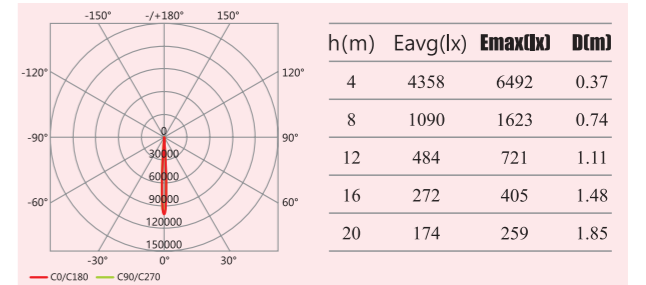

L02C-024A 60W 7°

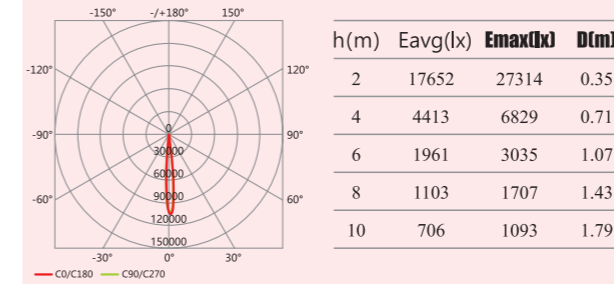

L02C-024A 60W 15°

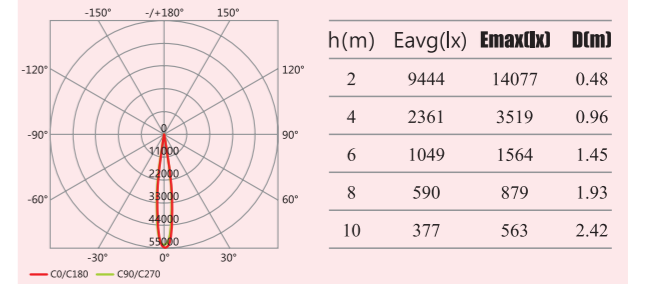

L02C-024A 60W 25°

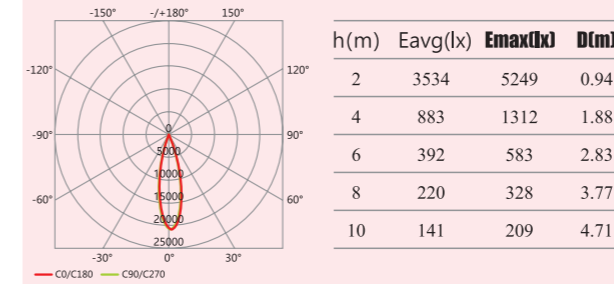

L02C-024A 60W 40°

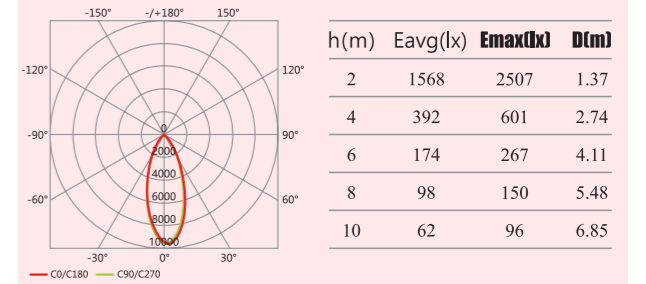

L02C-024A 60W 60°

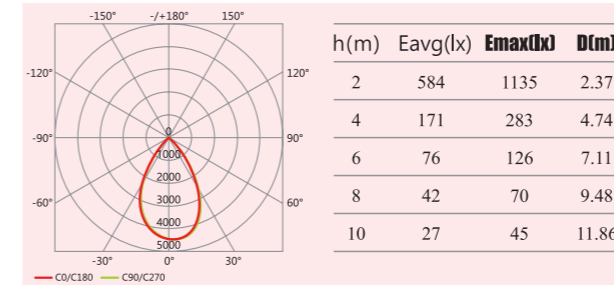

L02C-024A 60W 120°

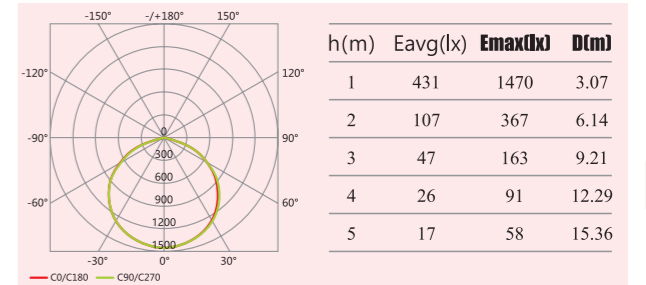

天玺 L02C-C 超级配光

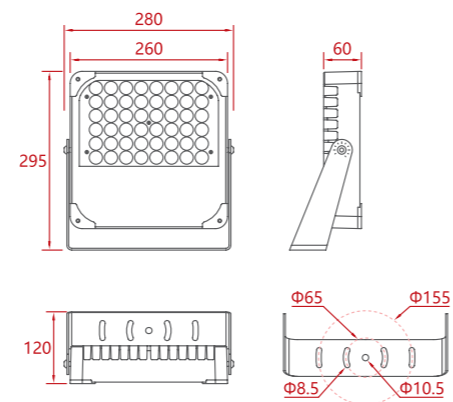
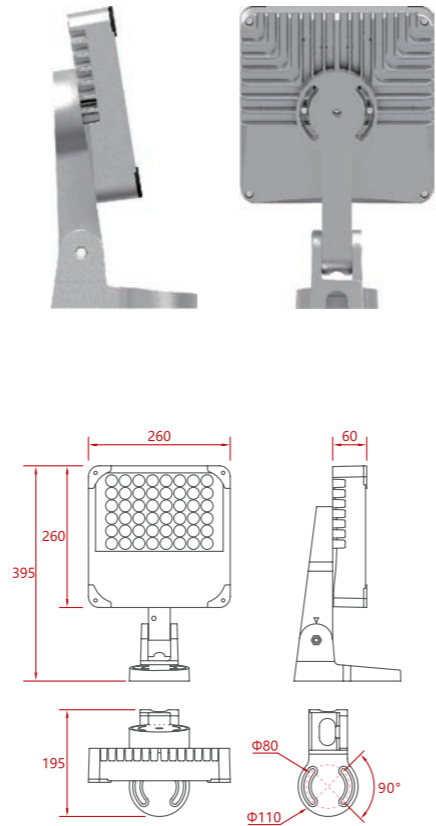

L02C-009C

AC 220V	LED Quantity	Rated Power	Luminous Flux	Optical Angle	Lamp Size	Net Weight	Gross Weight/Packing Size
	9pcs/RGBW	80 W	2752 lm	15°/25°/40°/60°	395×260×195mm	5.1 kg	5.4 kg/430×240×300(1pcs/box) 10.7 kg/480×460×420(2pcs/box)

L02C-012C

AC 220V	LED Quantity	Rated Power	Luminous Flux	Optical Angle	Lamp Size	Net Weight	Gross Weight/Packing Size
	12pcs/RGBW	100 W	3670 lm	15°/25°/40°/60°	395×260×195mm	5.2 kg	5.5 kg/430×240×300(1pcs/box) 10.9 kg/480×460×420(2pcs/box)

L02C-024C

AC 220V 3000/4000/5700K	LED Quantity	Rated Power	Luminous Flux	Optical Angle	Lamp Size	Net Weight	Gross Weight/Packing Size
	24 pcs	80 W	5279 lm	3°/5°	395×260×195mm	5.3 kg	5.6 kg/430×240×300(1pcs/box) 11.1 kg/480×460×420(2pcs/box)

L02C-036C

AC220V 3000/4000K/RGBW	LED Quantity	Rated Power	Luminous Flux	Optical Angle	Lamp Size	Net Weight	Gross Weight/Packing Size
	36 pcs	80 W	7400 lm	7°/10°/15°/25°/40°/60°/90°/120° 15°/55°/15°/30°/15°/45° 4°/50°/13°/40°/30°/60°	395×260×195mm	5.4 kg	5.7 kg/430×240×300(1pcs/box) 11.3 kg/480×460×420(2pcs/box)

L02C-048C

AC220V 3000/4000K/RGBW	LED Quantity	Rated Power	Luminous Flux	Optical Angle	Lamp Size	Net Weight	Gross Weight/Packing Size
	48 pcs	100 W	9867 lm	7°/10°/15°/25°/40°/60°/90°/120° 15°/55°/15°/30°/15°/45° 4°/50°/13°/40°/30°/60°	395×260×195mm	5.5 kg	5.8 kg/430×240×300(1pcs/box) 11.5 kg/480×460×420(2pcs/box)

L02C-024C 80W 3°

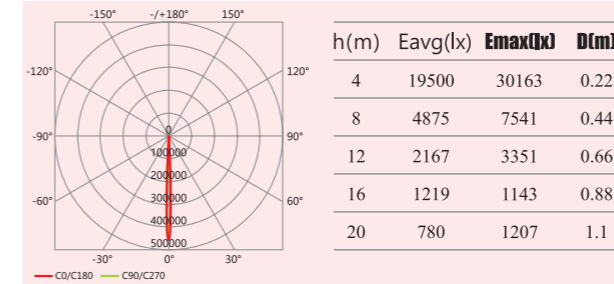

L02C-024C 80W 5°

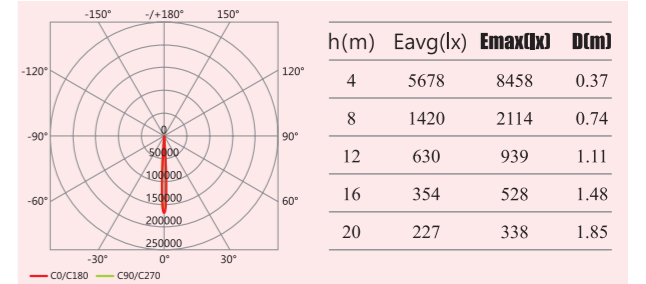

L02C-048C 100W 7°

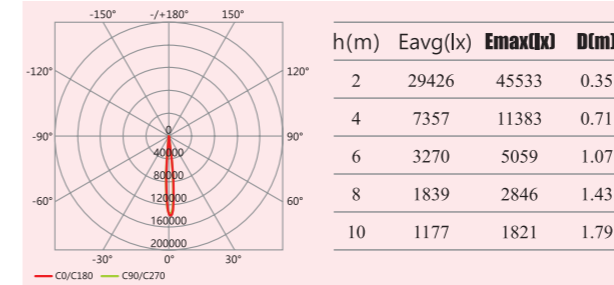

L02C-048C 100W 15°

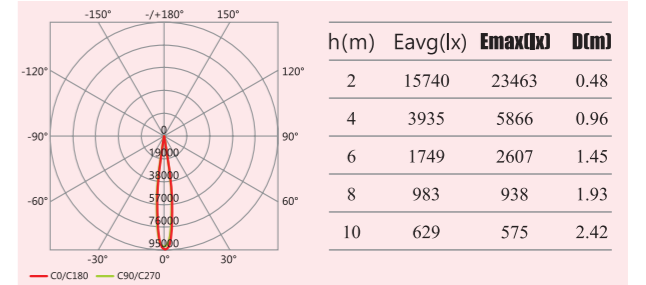

L02C-048C 100W 25°

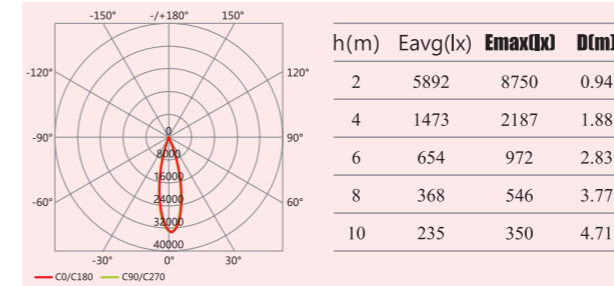

L02C-048C 100W 40°

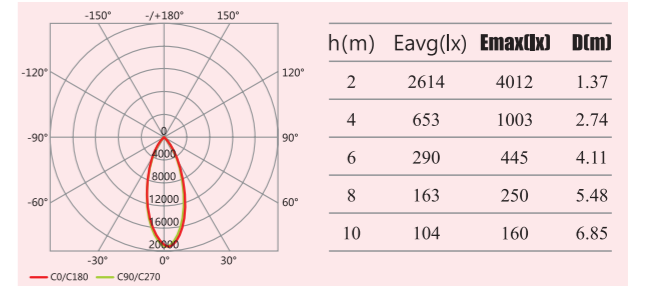

L02C-048C 100W 60°

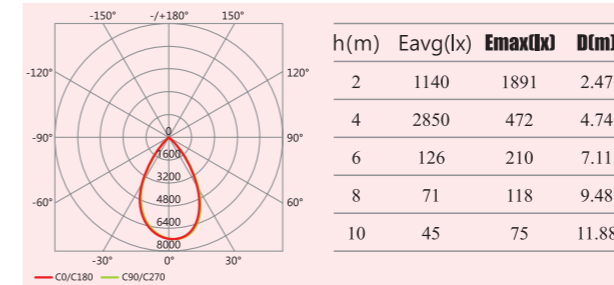

L02C-048C 100W 120°

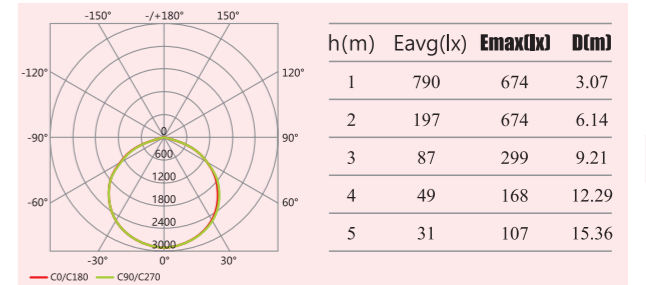

L02C-E

IP66 IK08 CE

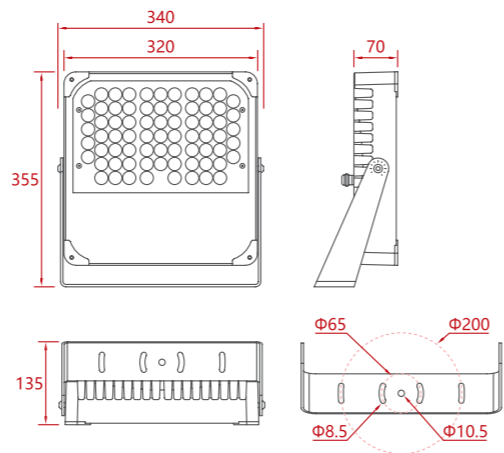
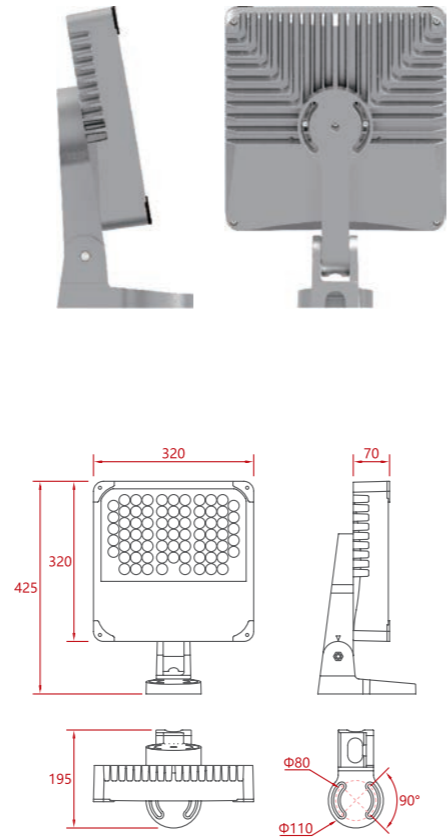

L02C-016E

AC 220V



LED Quantity	Rated Power	Luminous Flux	Optical Angle	Lamp Size	Net Weight	Gross Weight/Packing Size
16pcs/RGBW	120 W	4340 lm	15°/25°/40°/60°	425×320×195mm	7.0 kg	7.9 kg/520×390×260(1pcs/box)

L02C-020E

AC 220V



LED Quantity	Rated Power	Luminous Flux	Optical Angle	Lamp Size	Net Weight	Gross Weight/Packing Size
20pcs/RGBW	150 W	5425 lm	15°/25°/40°/60°	425×320×195mm	7.2 kg	8.1 kg/520×390×260(1pcs/box)

L02C-032E

AC 220V
3000/4000/5700K



LED Quantity	Rated Power	Luminous Flux	Optical Angle	Lamp Size	Net Weight	Gross Weight/Packing Size
32 pcs	100 W	6779 lm	3°/5°	425×320×195mm	7.4 kg	8.3 kg/520×390×260(1pcs/box)

L02C-056E

AC220V
3000/4000K/RGBW



LED Quantity	Rated Power	Luminous Flux	Optical Angle	Lamp Size	Net Weight	Gross Weight/Packing Size
56 pcs	120 W	11503 lm	7°/10°/15°/25°/40°/60°/90°/120° 15×55°/15×30°/15×45° 4×50°/13×40°/30×60°	425×320×195mm	7.5 kg	8.4 kg/520×390×260(1pcs/box)

L02C-072E

AC220V
3000/4000K/RGBW



LED Quantity	Rated Power	Luminous Flux	Optical Angle	Lamp Size	Net Weight	Gross Weight/Packing Size
72 pcs	150 W	14791 lm	7°/10°/15°/25°/40°/60°/90°/120° 15×55°/15×30°/15×45° 4×50°/13×40°/30×60°	425×320×195mm	7.6 kg	8.5 kg/520×390×260(1pcs/box)

L02C-032E 100W 3°

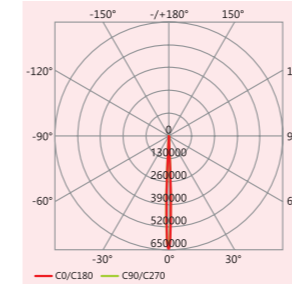

h(m)	Eavg(lx)	Emax(Dlx)	D(m)
4	26162	40468	0.22
8	6541	10117	0.44
12	2907	4496	0.66
16	1635	2529	0.88
20	1046	1619	1.1

L02C-032E 100W 5°

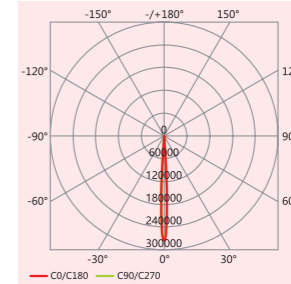

h(m)	Eavg(lx)	Emax(Dlx)	D(m)
4	11911	17741	0.36
8	2978	4435	0.73
12	1323	1971	1.09
16	744	1109	1.46
20	476	709	1.82

L02C-072E 150W 7°

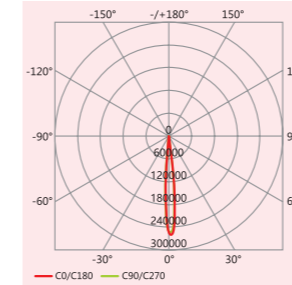

h(m)	Eavg(lx)	Emax(Dlx)	D(m)
4	11108	17189	0.71
8	2777	4297	1.42
12	1234	1910	2.15
16	694	1074	2.86
20	444	687	3.58

L02C-072E 150W 15°

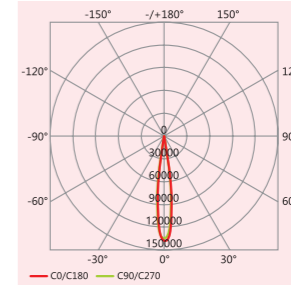

h(m)	Eavg(lx)	Emax(Dlx)	D(m)
4	5902	8799	0.97
8	1476	2200	1.94
12	655	977	2.91
16	368	549	3.88
20	236	351	4.85

L02C-072E 150W 25°

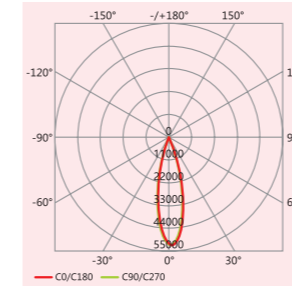

h(m)	Eavg(lx)	Emax(Dlx)	D(m)
4	2209	3281	1.88
8	552	820	3.77
12	245	364	5.66
16	138	205	7.55
20	88	131	9.43

L02C-072E 150W 40°

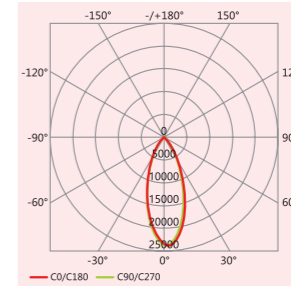

h(m)	Eavg(lx)	Emax(Dlx)	D(m)
4	1504	2957	2.74
8	376	739	5.48
12	167	328	8.22
16	94	184	10.96
20	22	118	13.7

L02C-072E 150W 60°

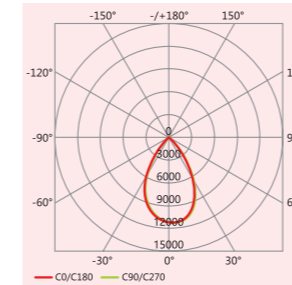

h(m)	Eavg(lx)	Emax(Dlx)	D(m)
4	427	709	4.74
8	106	177	9.48
12	47	78	14.23
16	26	44	18.97
20	17	28	23.72

L02C-072C 150W 120°

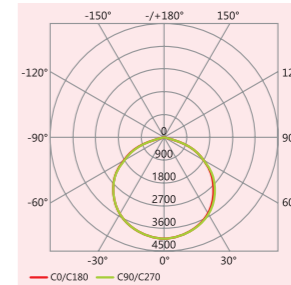

h(m)	Eavg(lx)	Emax(Dlx)	D(m)
1	1186	4044	3.07
2	296	1011	6.14
3	131	449	9.21
4	74	252	12.29
5	47	161	15.36

AT1



AT9



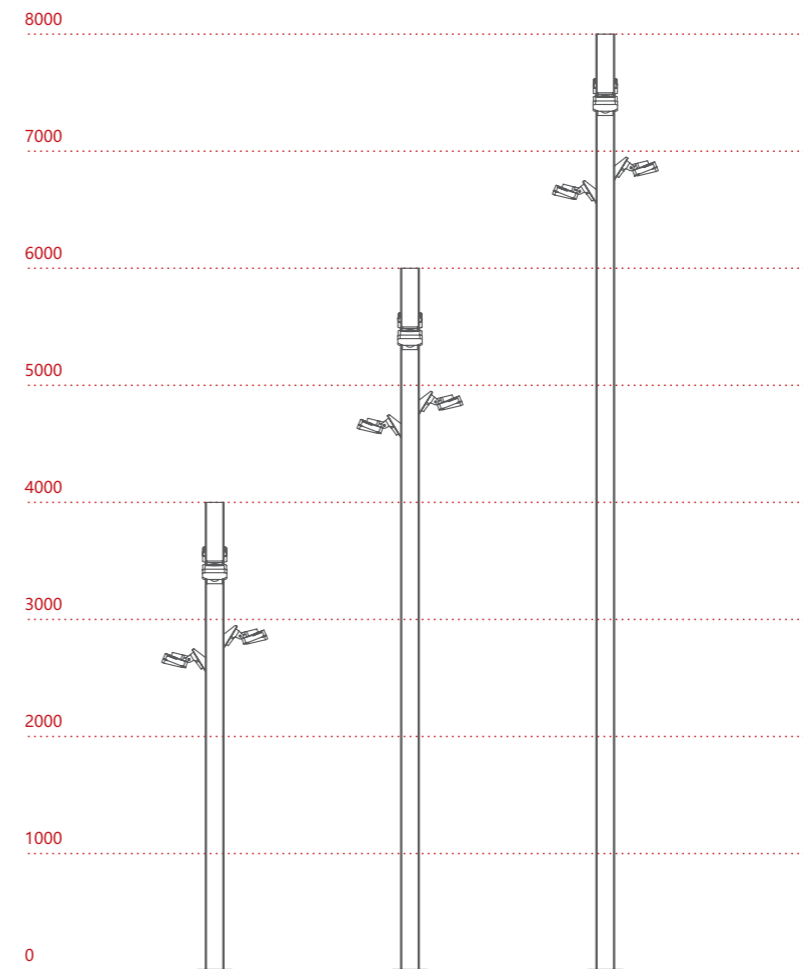
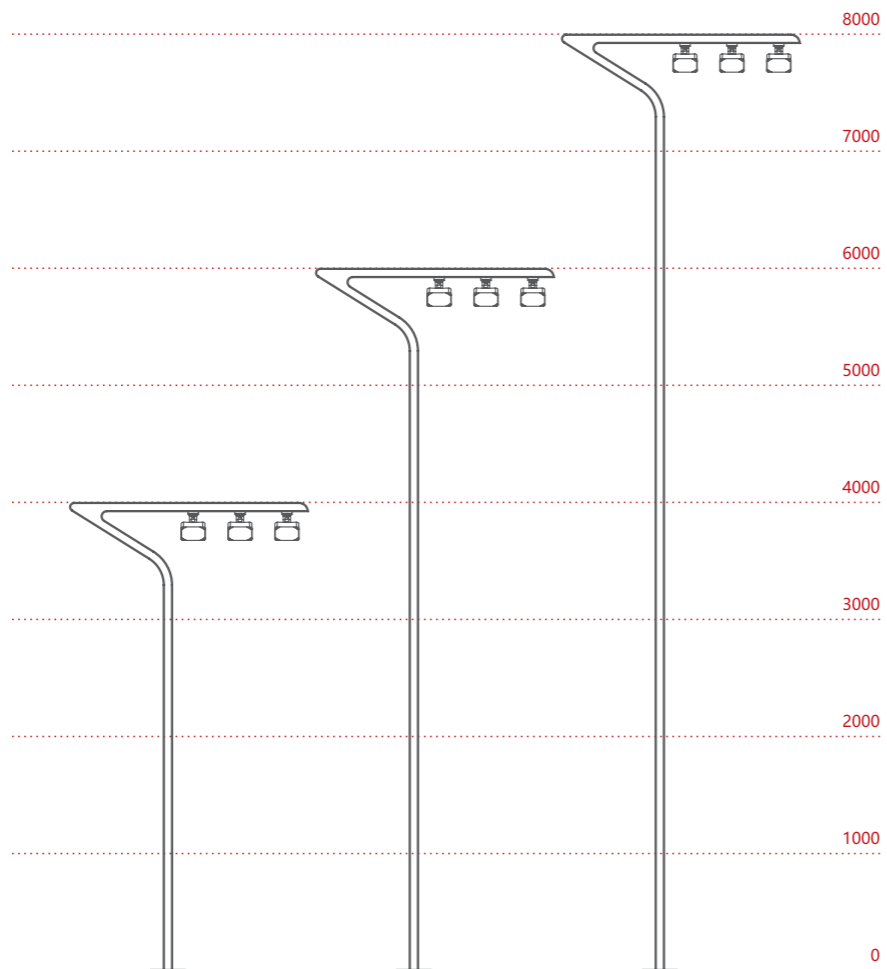

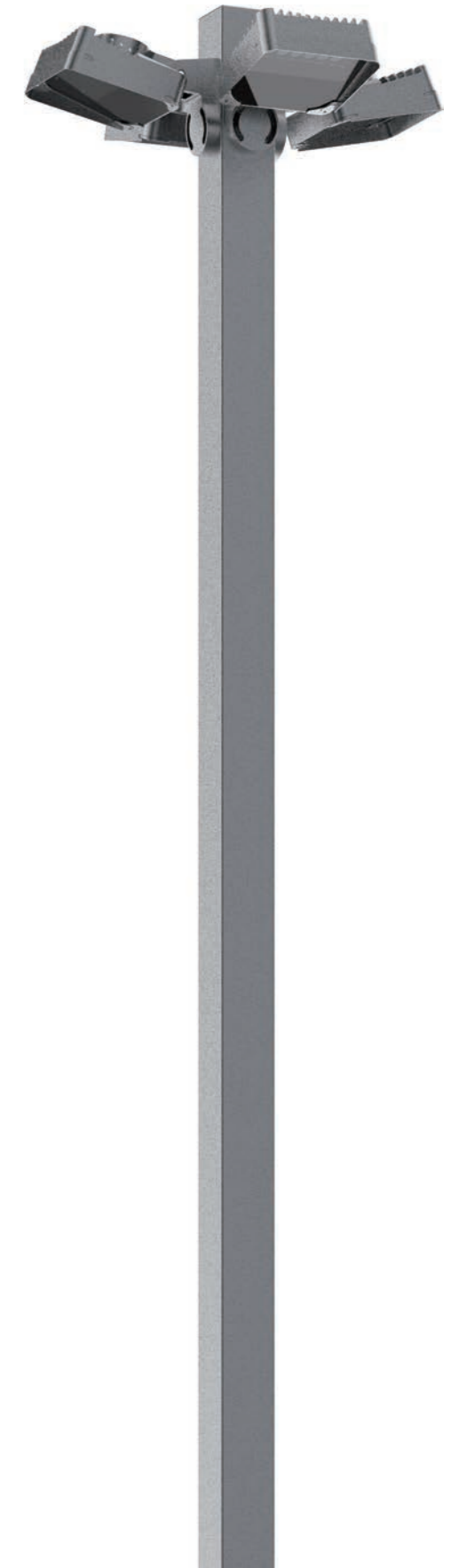
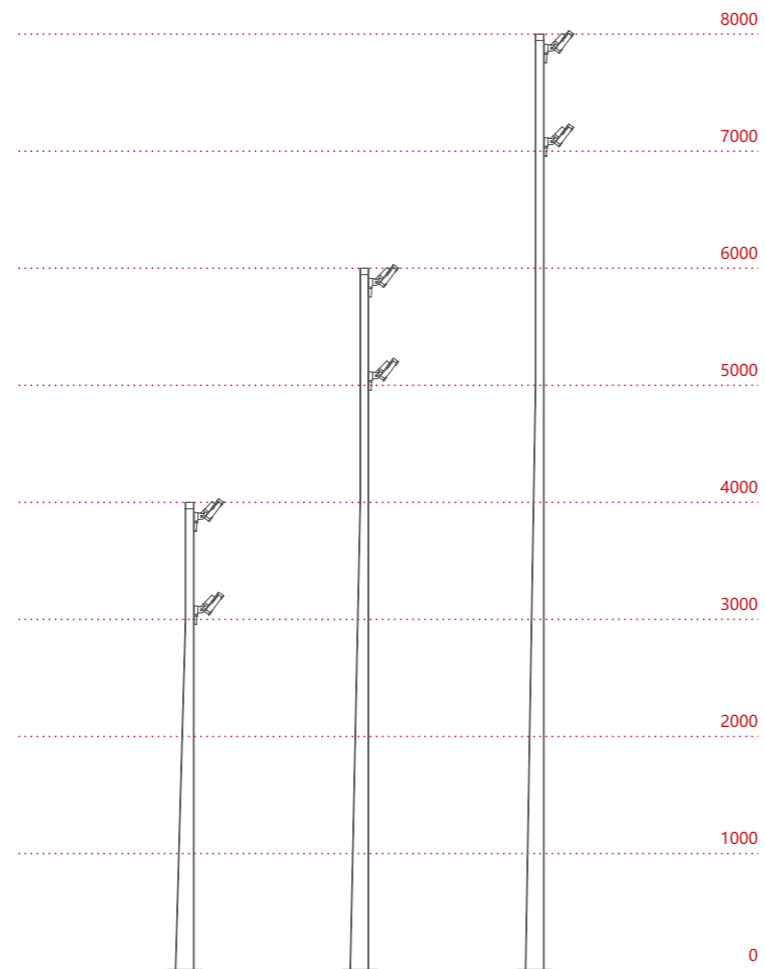

配件 ACCESSORY

外置遮光罩 External anti-glare cover

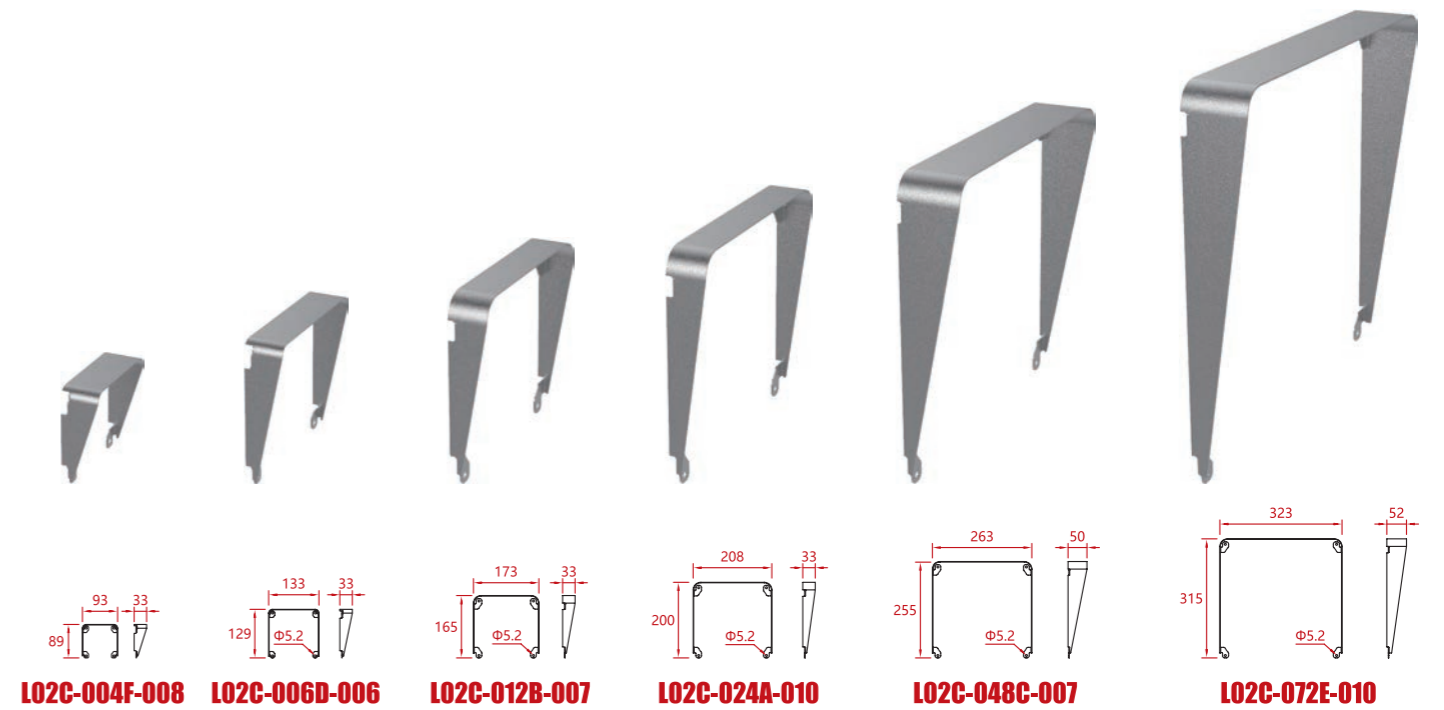
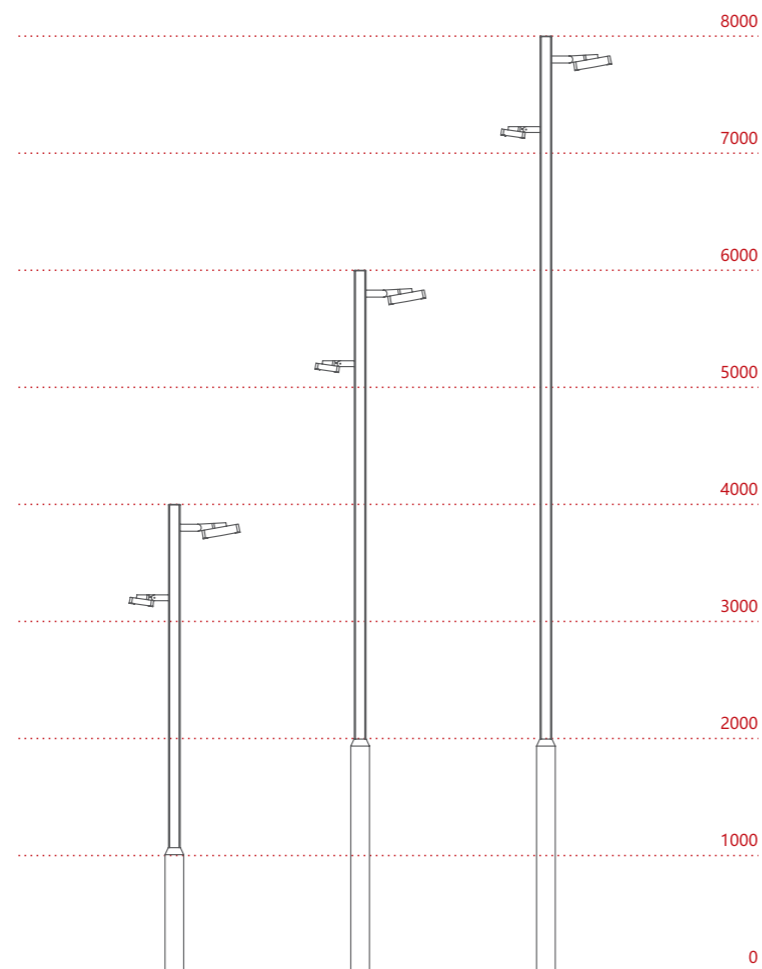
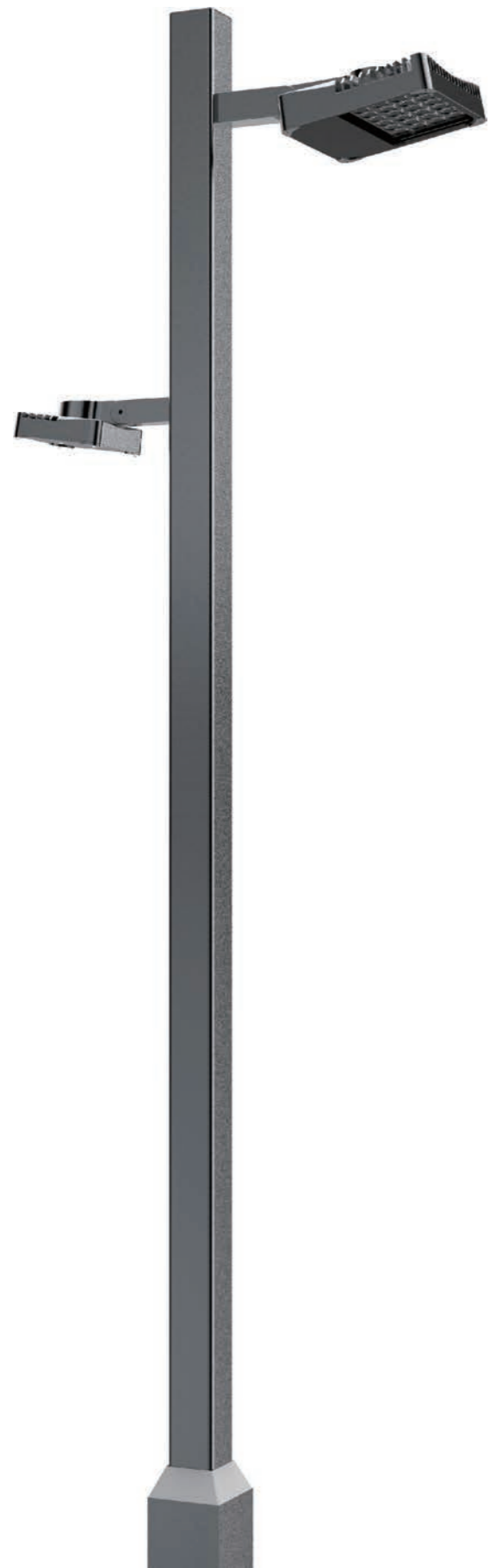

内置蜂窝防眩网 Honeycomb net for anti-glare

